

Amusement Park (Roller Coaster)

For parts whose glue spot number is on the outside, write the number on the back so that you can keep track of which part is which after cutting out.

Assemble in page order, following the pictures and diagrams closely.

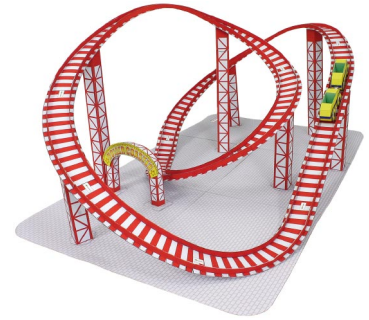
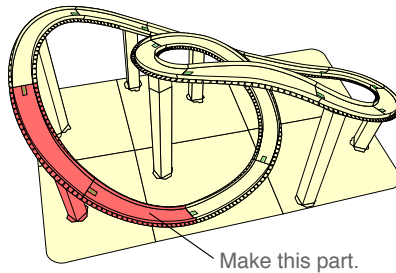

Make this part.

Cut out after applying glue.

Cut out after applying glue.
For the other parts also,
cut out the orange parts
after gluing all the glue tabs.

A block

Assembly



Cut line
Cut along the line.



Mountain fold
Make a mountain fold along the line.



Valley fold
Make a valley fold along the line.



Glue spot
Glue together.

You will need

scissors, ruler, glue (we recommend woodwork glue)

Assembly tip

Fold along the mountain fold and valley fold lines to make creases.

Caution

Be very careful when handling scissors.
Keep glue away from small children.



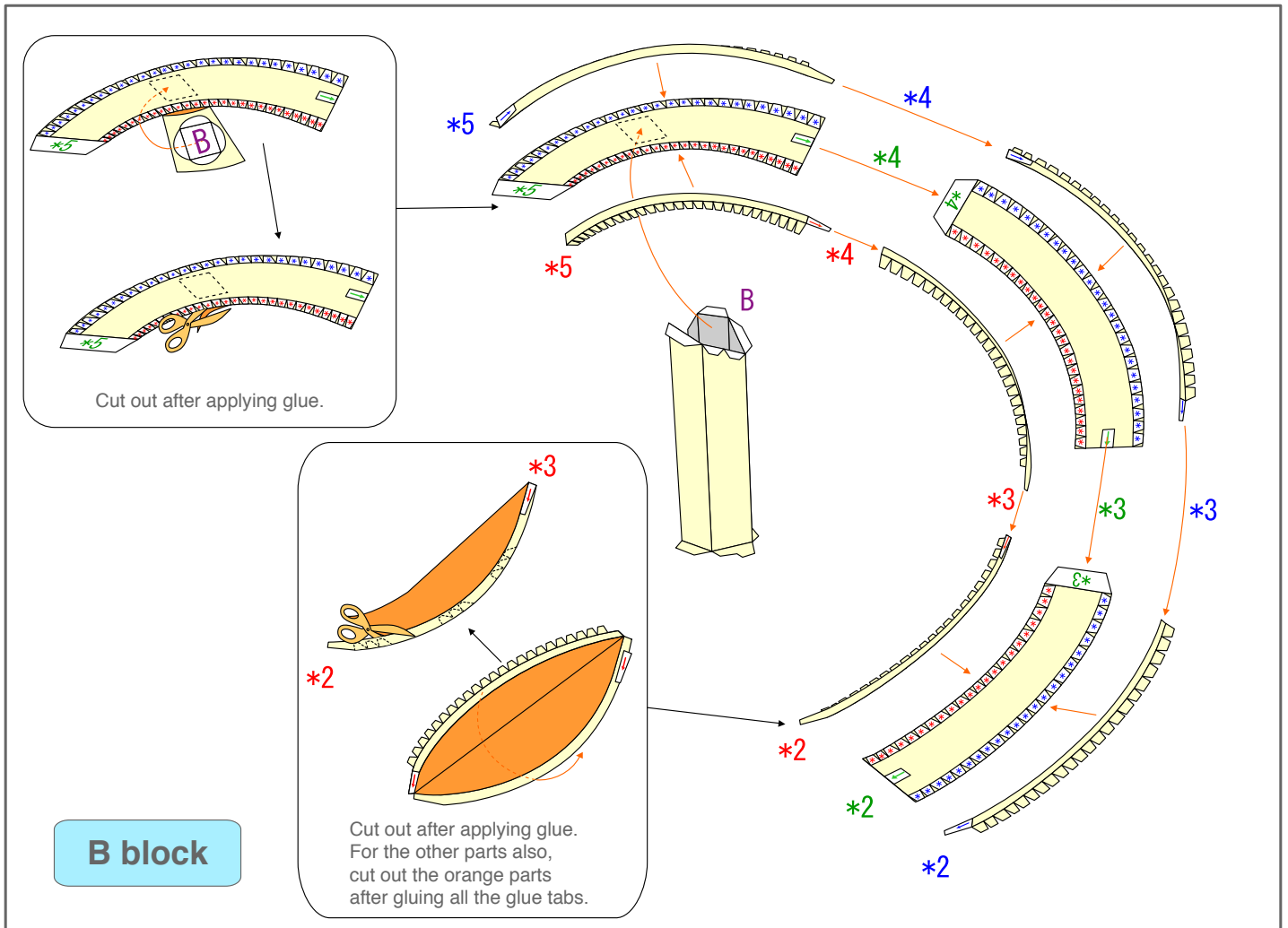
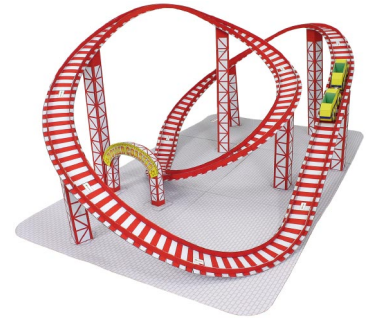
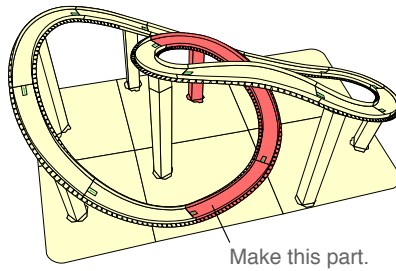

Amusement Park (Roller Coaster)

For parts whose glue spot number is on the outside, write the number on the back so that you can keep track of which part is which after cutting out.

Assemble in page order, following the pictures and diagrams closely.



Assembly

-  ——— **Cut line**
Cut along the line.
-  - - - - - **Mountain fold**
Make a mountain fold along the line.
-  - - - - - **Valley fold**
Make a valley fold along the line.
-  * **Glue spot**
Glue together.

- You will need**
scissors, ruler, glue (we recommend woodwork glue)
- Assembly tip**
Fold along the mountain fold and valley fold lines to make creases.
- Caution**
Be very careful when handling scissors.
Keep glue away from small children.

Amusement Park (Roller Coaster)

For parts whose glue spot number is on the outside, write the number on the back so that you can keep track of which part is which after cutting out.

Assemble in page order, following the pictures and diagrams closely.

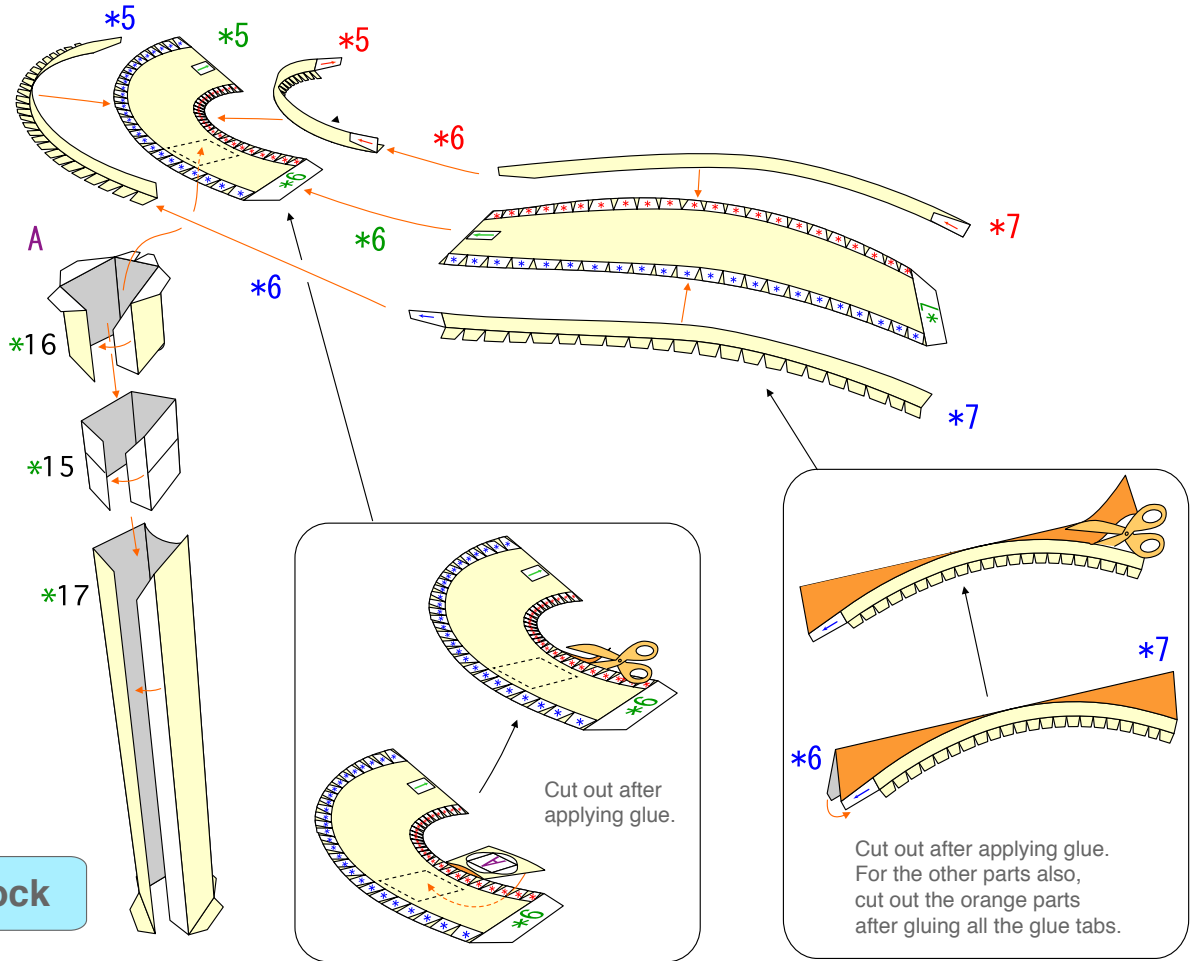
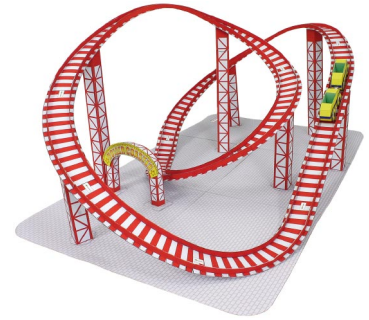
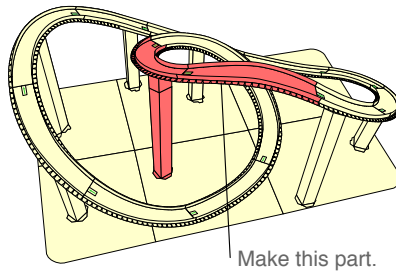

Assembly



Cut line

Cut along the line.



Mountain fold

Make a mountain fold along the line.



Valley fold

Make a valley fold along the line.



Glue spot

Glue together.

You will need

scissors, ruler, glue (we recommend woodwork glue)

Assembly tip

Fold along the mountain fold and valley fold lines to make creases.

Caution

Be very careful when handling scissors.
Keep glue away from small children.

Amusement Park (Roller Coaster)

For parts whose glue spot number is on the outside, write the number on the back so that you can keep track of which part is which after cutting out.

Assemble in page order, following the pictures and diagrams closely.

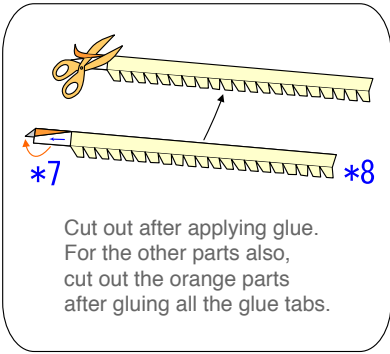
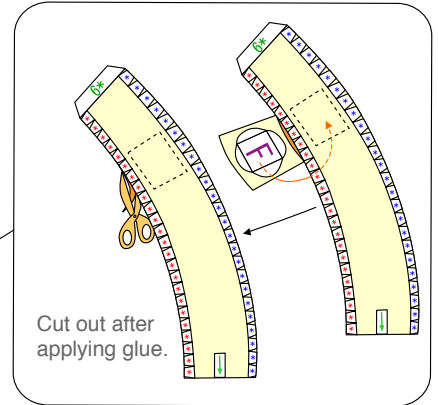
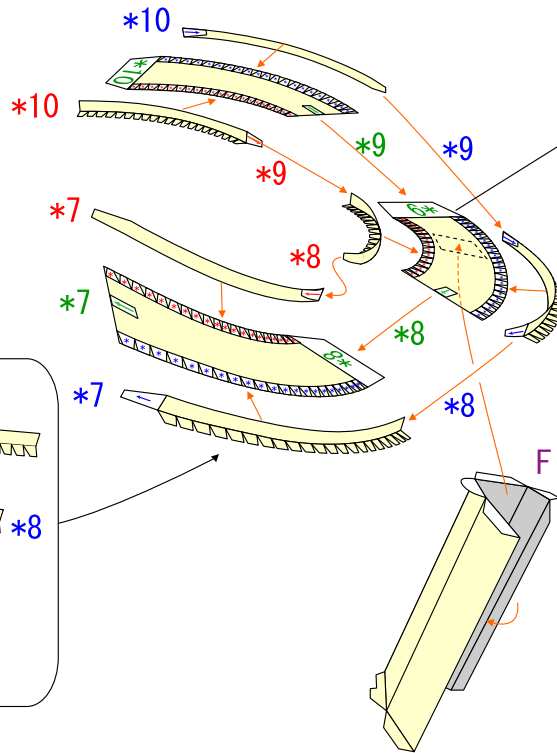
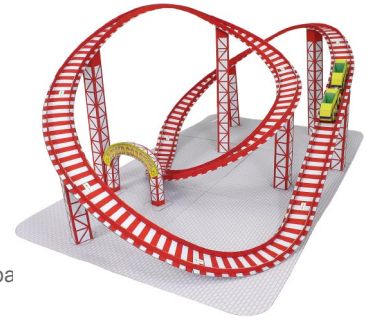
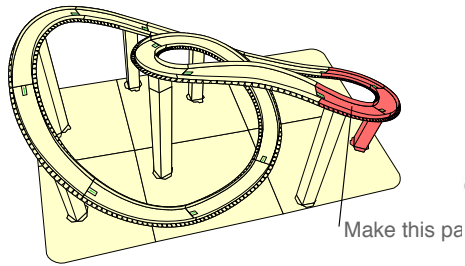

D block

Assembly



Cut line
Cut along the line.



Mountain fold
Make a mountain fold along the line.



Valley fold
Make a valley fold along the line.



Glue spot
Glue together.

You will need

scissors, ruler, glue (we recommend woodwork glue)

Assembly tip

Fold along the mountain fold and valley fold lines to make creases.

Caution

Be very careful when handling scissors.
Keep glue away from small children.

Amusement Park (Roller Coaster)

For parts whose glue spot number is on the outside, write the number on the back so that you can keep track of which part is which after cutting out.

Assemble in page order, following the pictures and diagrams closely.

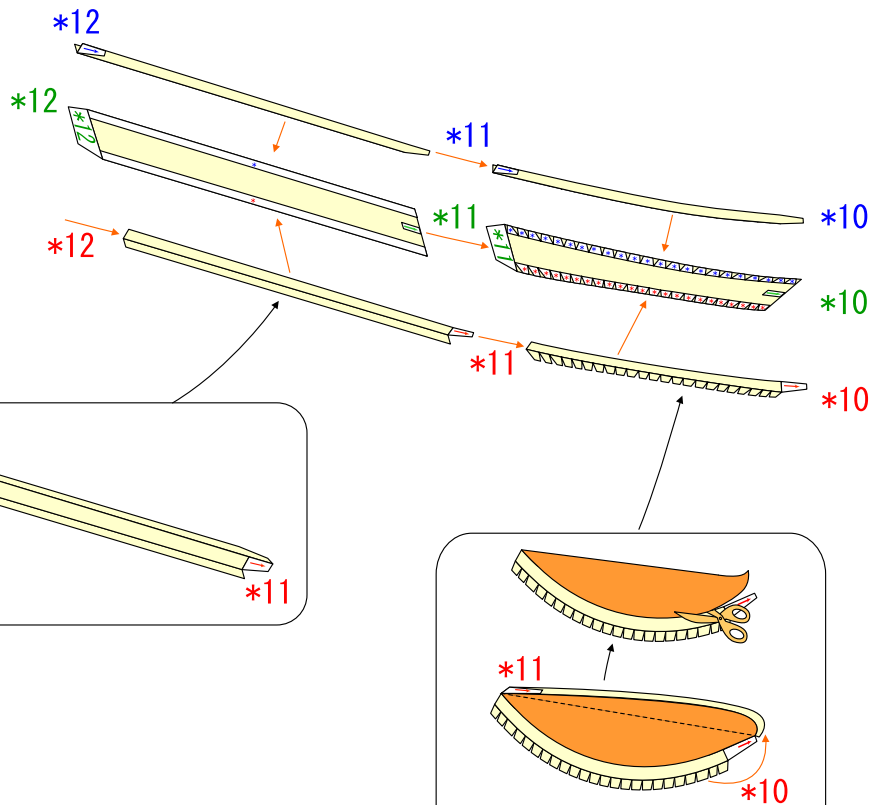
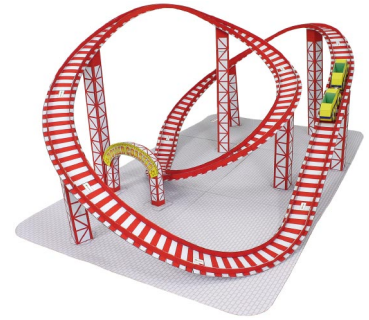
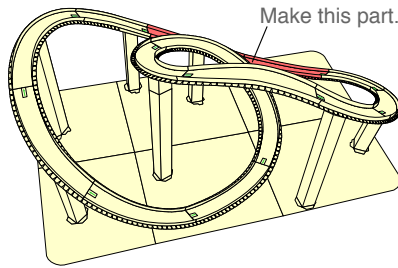

E block

Cut out after applying glue.
For the other parts also,
cut out the orange parts
after gluing all the glue tabs.

Assembly



Cut line
Cut along the line.



Mountain fold
Make a mountain fold along the line.



Valley fold
Make a valley fold along the line.



*

Glue spot
Glue together.

You will need

scissors, ruler, glue (we recommend woodwork glue)

Assembly tip

Fold along the mountain fold and valley fold lines to make creases.

Caution

Be very careful when handling scissors.
Keep glue away from small children.

Amusement Park (Roller Coaster)

For parts whose glue spot number is on the outside, write the number on the back so that you can keep track of which part is which after cutting out.

Assemble in page order, following the pictures and diagrams closely.

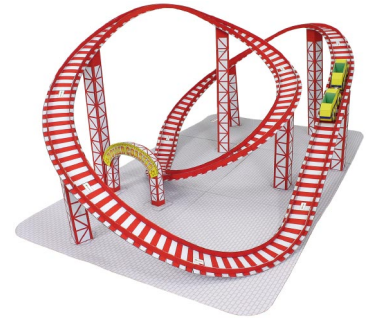
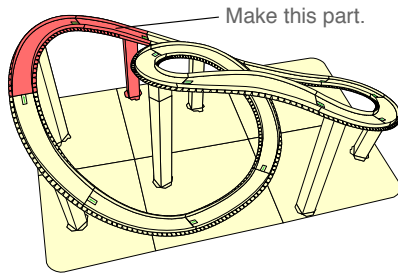

F block

*13 Cut out after applying glue.

*14

*12 Cut out after applying glue.

*13

*12

*13

*12

*14

*13

*12

E

*13 Cut out after applying glue.

*12

*14 Cut out after applying glue.

Assembly



Cut line
Cut along the line.



Mountain fold
Make a mountain fold along the line.



Valley fold
Make a valley fold along the line.



Glue spot
Glue together.

You will need

scissors, ruler, glue (we recommend woodwork glue)

Assembly tip

Fold along the mountain fold and valley fold lines to make creases.

Caution

Be very careful when handling scissors.
Keep glue away from small children.

Amusement Park (Roller Coaster)

For parts whose glue spot number is on the outside, write the number on the back so that you can keep track of which part is which after cutting out.

Assemble in page order, following the pictures and diagrams closely.

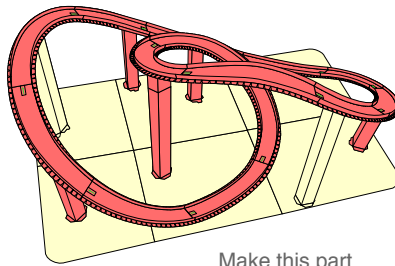

Make this part.

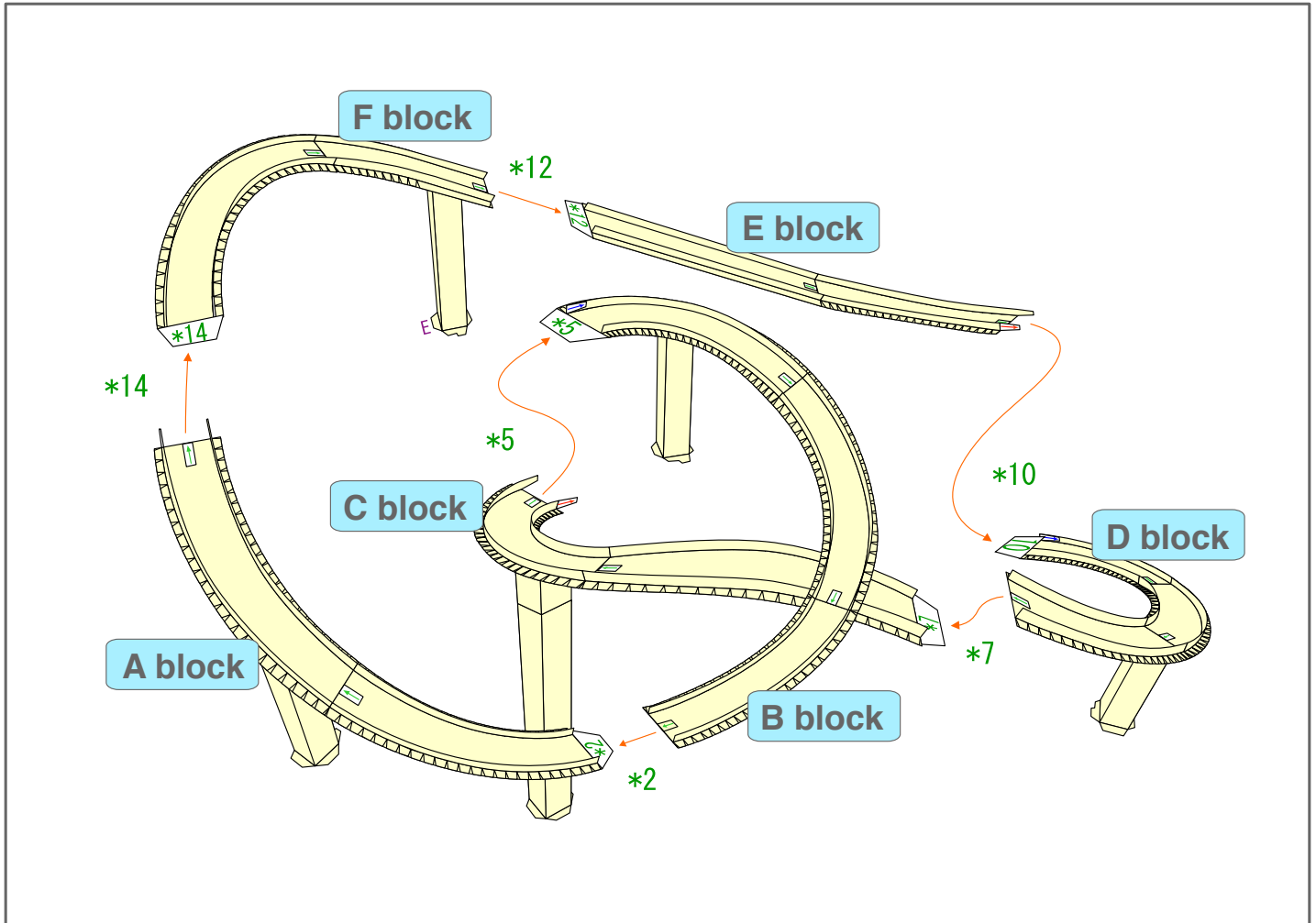
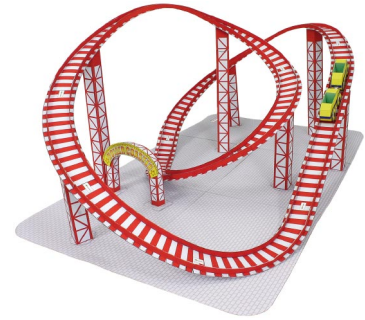

Assembly



Cut line
Cut along the line.



Mountain fold
Make a mountain fold along the line.



Valley fold
Make a valley fold along the line.



Glue spot
Glue together.

You will need

scissors, ruler, glue (we recommend woodwork glue)

Assembly tip

Fold along the mountain fold and valley fold lines to make creases.

Caution

Be very careful when handling scissors.
Keep glue away from small children.

Amusement Park (Roller Coaster)

For parts whose glue spot number is on the outside, write the number on the back so that you can keep track of which part is which after cutting out.

Assemble in page order, following the pictures and diagrams closely.

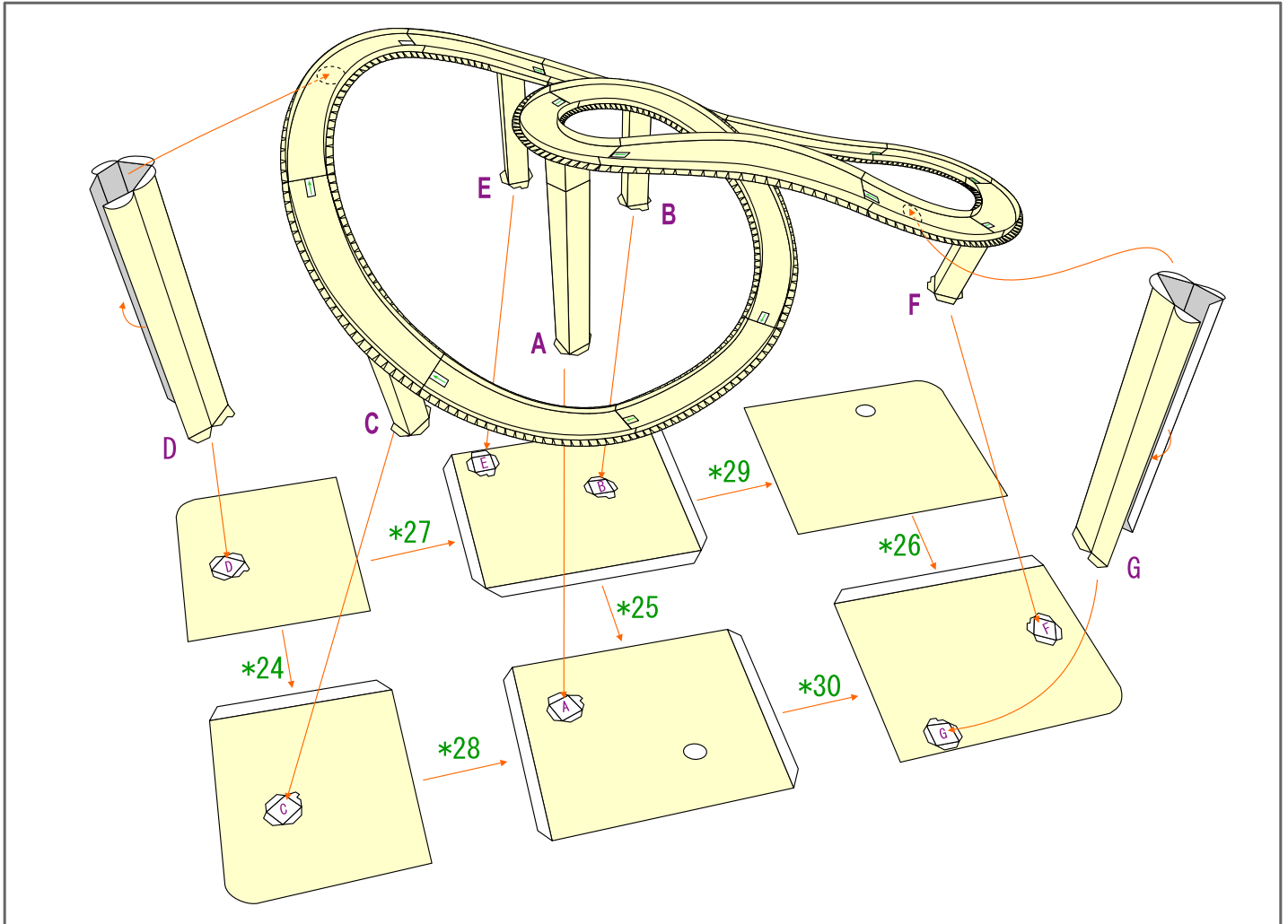
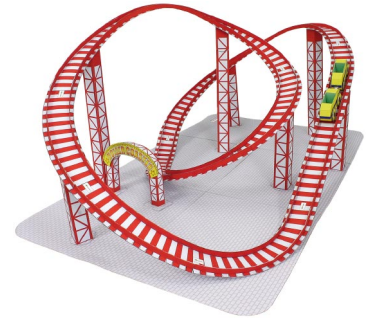
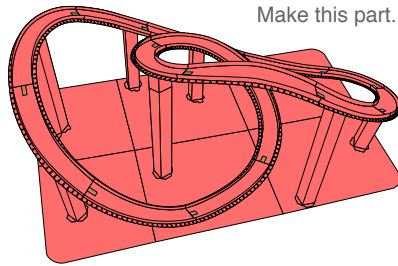

Assembly



Cut line

Cut along the line.



Mountain fold

Make a mountain fold along the line.



Valley fold

Make a valley fold along the line.



Glue spot

Glue together.

You will need

scissors, ruler, glue (we recommend woodwork glue)

Assembly tip

Fold along the mountain fold and valley fold lines to make creases.

Caution

Be very careful when handling scissors.
Keep glue away from small children.

Amusement Park (Roller Coaster)

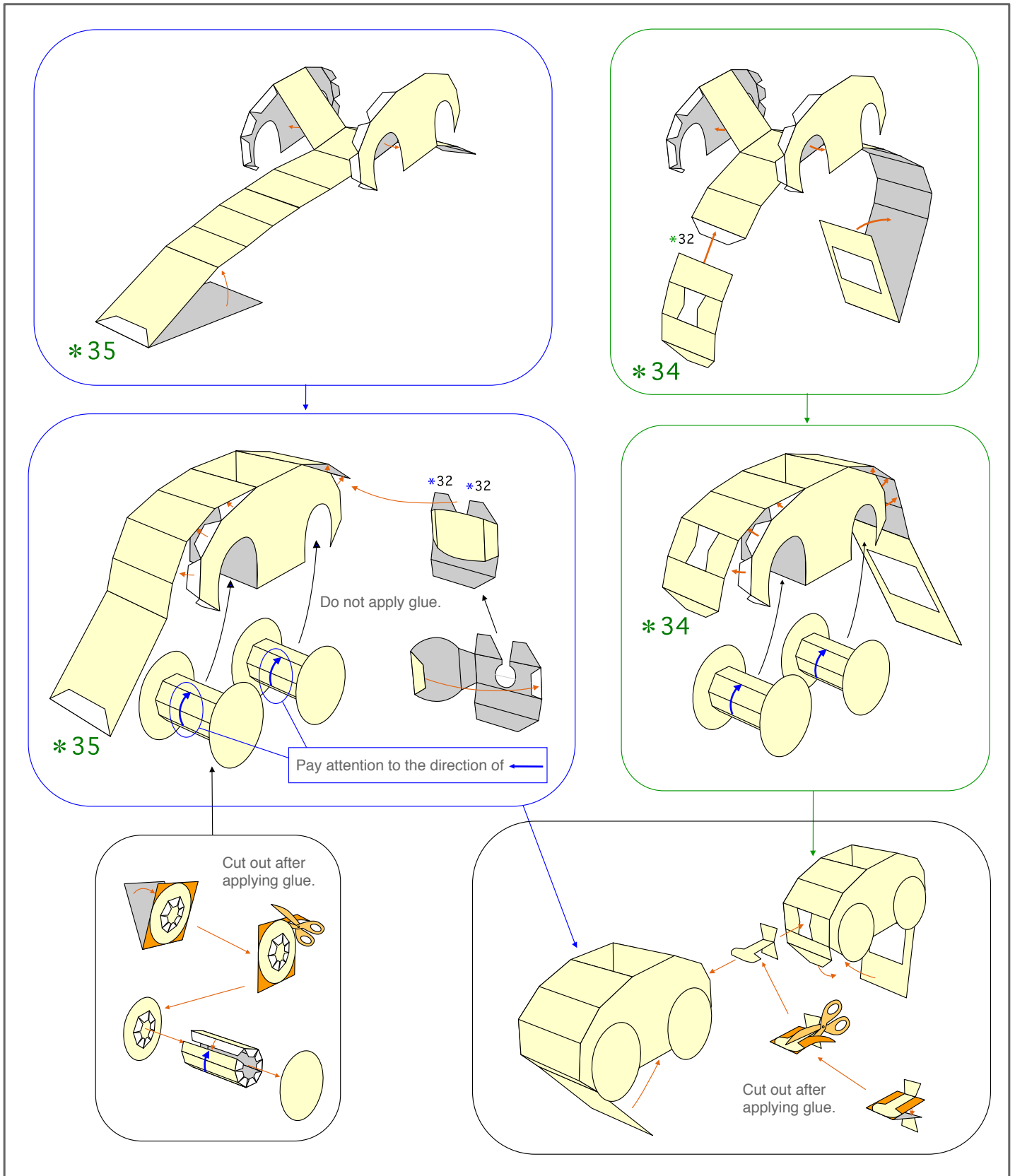

Amusement Park (Roller Coaster)

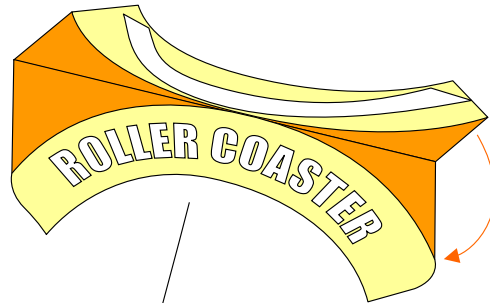

Cut out after applying glue.

