

Viking craft, Norway: Assembly Instructions

Canon ® is a registered trademark of Canon Inc. © Canon Inc. © Y.Watanabe



PAPER CRAFT

<http://www.canon.com/c-park/en/>



View of completed model

Viking craft, Norway

The scourge of Europe from roughly the ninth through the 11th centuries, the Vikings and their fast, seaworthy vessels are said to have reached as far as North America around 500 years before Columbus. These craft were characterized by a single central mast about 20 meters high and a single sail. A partially preserved vessel has been discovered on the shores of Norway's Oslo Fjord.

*This model was designed for Papercraft and may differ from the original in some respects.

■ Parts list(pattern): Five US letter sheets (No.5 to No.9)

■ No. of Parts: 85

*Build the model by carefully reading the Assembly Instructions, in the parts sheet page order.

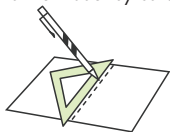

*Hint: Trace along the folds with a ruler and an exhausted (no ink) to get a sharper, easier fold.

Before starting assembly: Writing the number of each section on its back side before cutting out the sections is highly recommended.
(* This way, you can be sure which section is which even after cutting out the sections.)

→ Indicates where sections should be glued together.
 Indicates sections that should be glued first, then cut out.

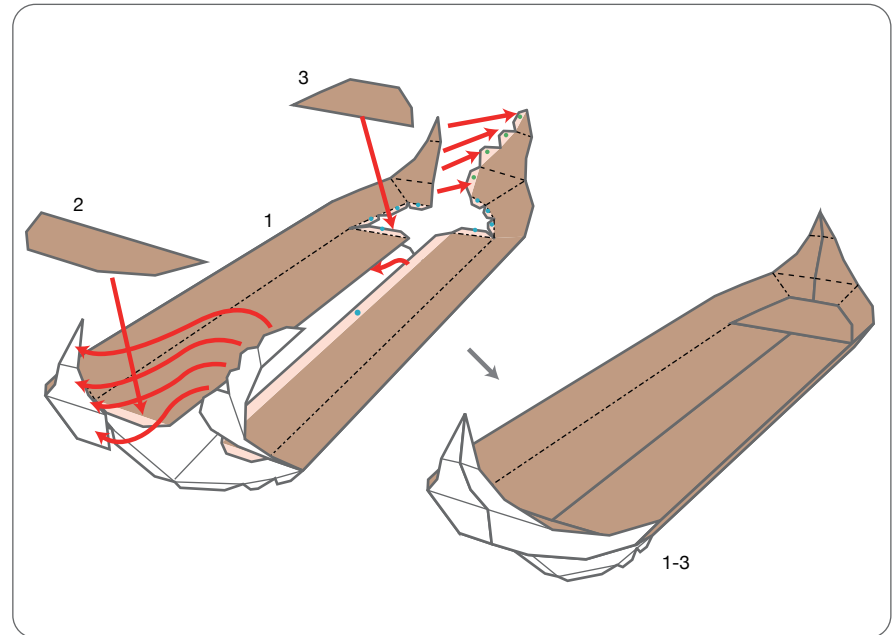

Assembly Instructions

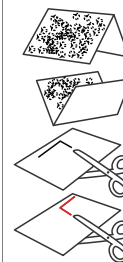

Mountain fold(dotted line)

Make a mountain fold.

Valley fold(dashed and dotted line)

Make a valley fold.

Scissors line(solid line)

Cut along the line.

Cut in line(solid line)

Cut along the line.

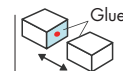

The glue spot(colored dot) shows where to apply the glue.

Glue spot(Red dot)

Glue parts with the same number together.

Glue spot(Green dot)

Glue within the same part.

Glue spot(Blue dot)

Glue to the rear of the other part.

Tools and materials



Scissors, set square, glue(We recommend stick glue), pencil, used ballpoint pen, toothpicks, tweezers, (useful for handling small parts)

Assembly tip



Before gluing, crease the paper along mountain fold and valley fold lines and make sure rounded sections are nice and stiff.

Caution



Glue, scissors and other tools may be dangerous to young children so be sure to keep them out of the reach of young children.

Viking craft, Norway: Assembly Instructions

Canon® is a registered trademark of Canon Inc. © Canon Inc. © Y.Watanabe

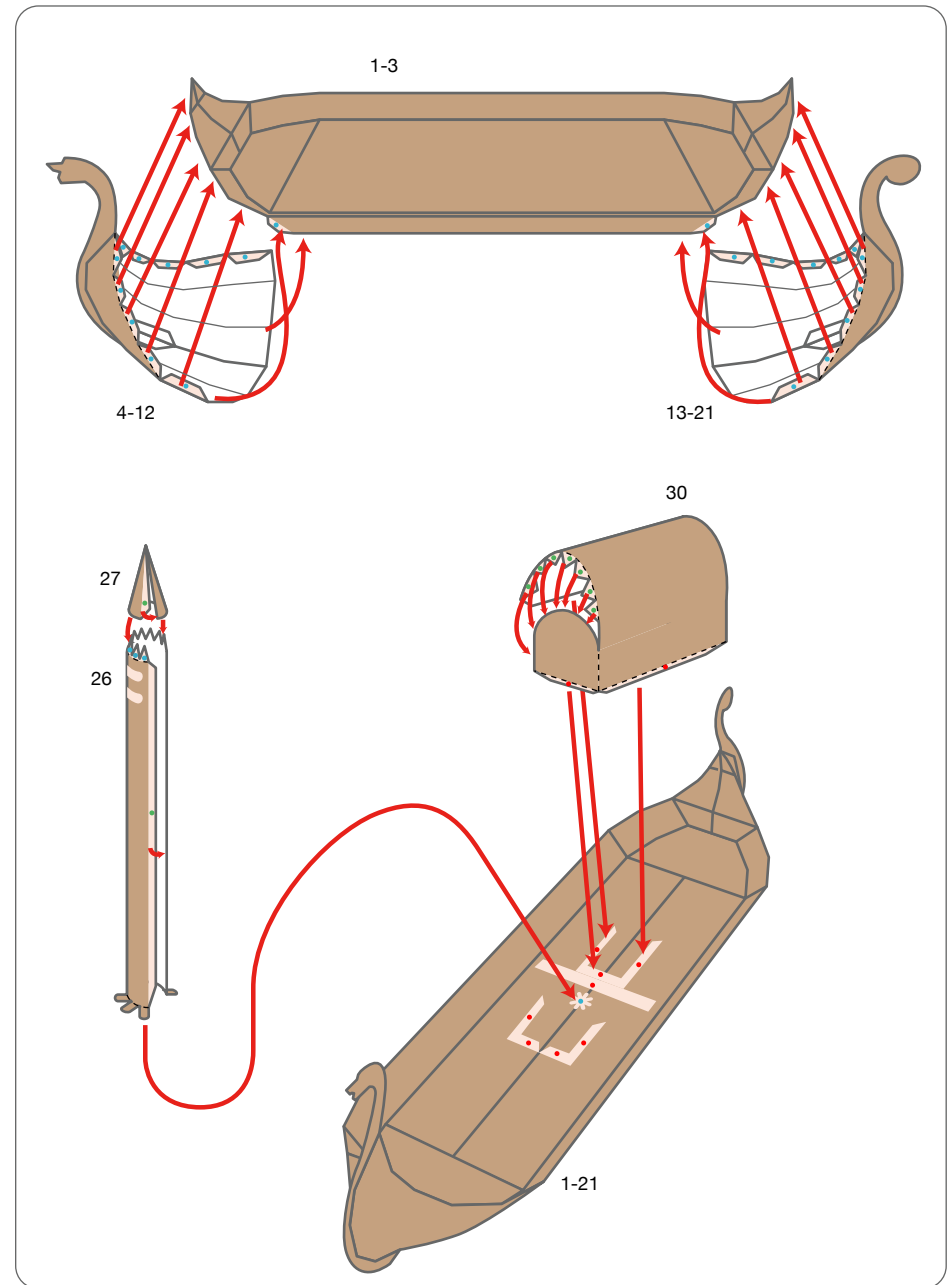
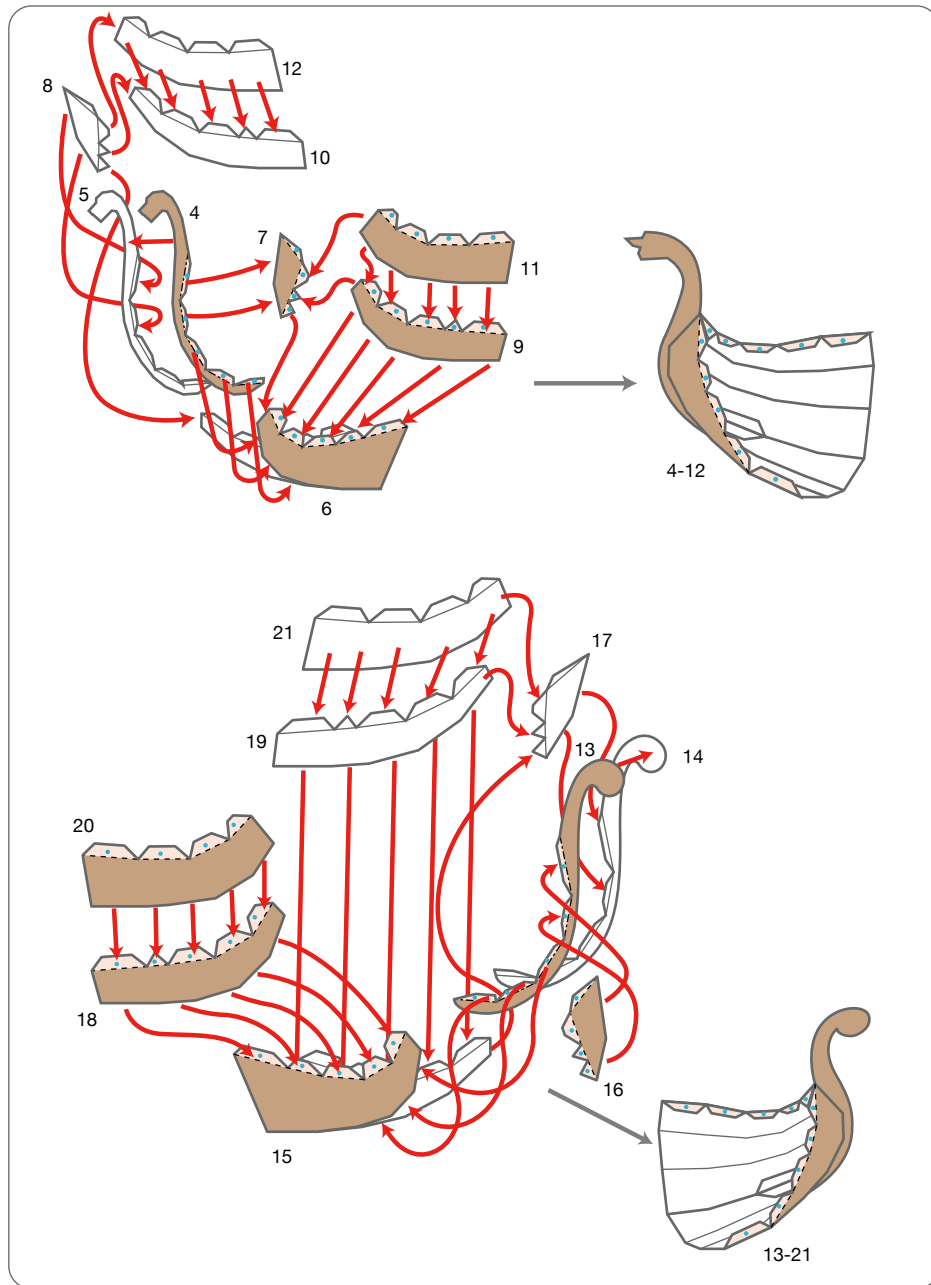

Viking craft, Norway: Assembly Instructions

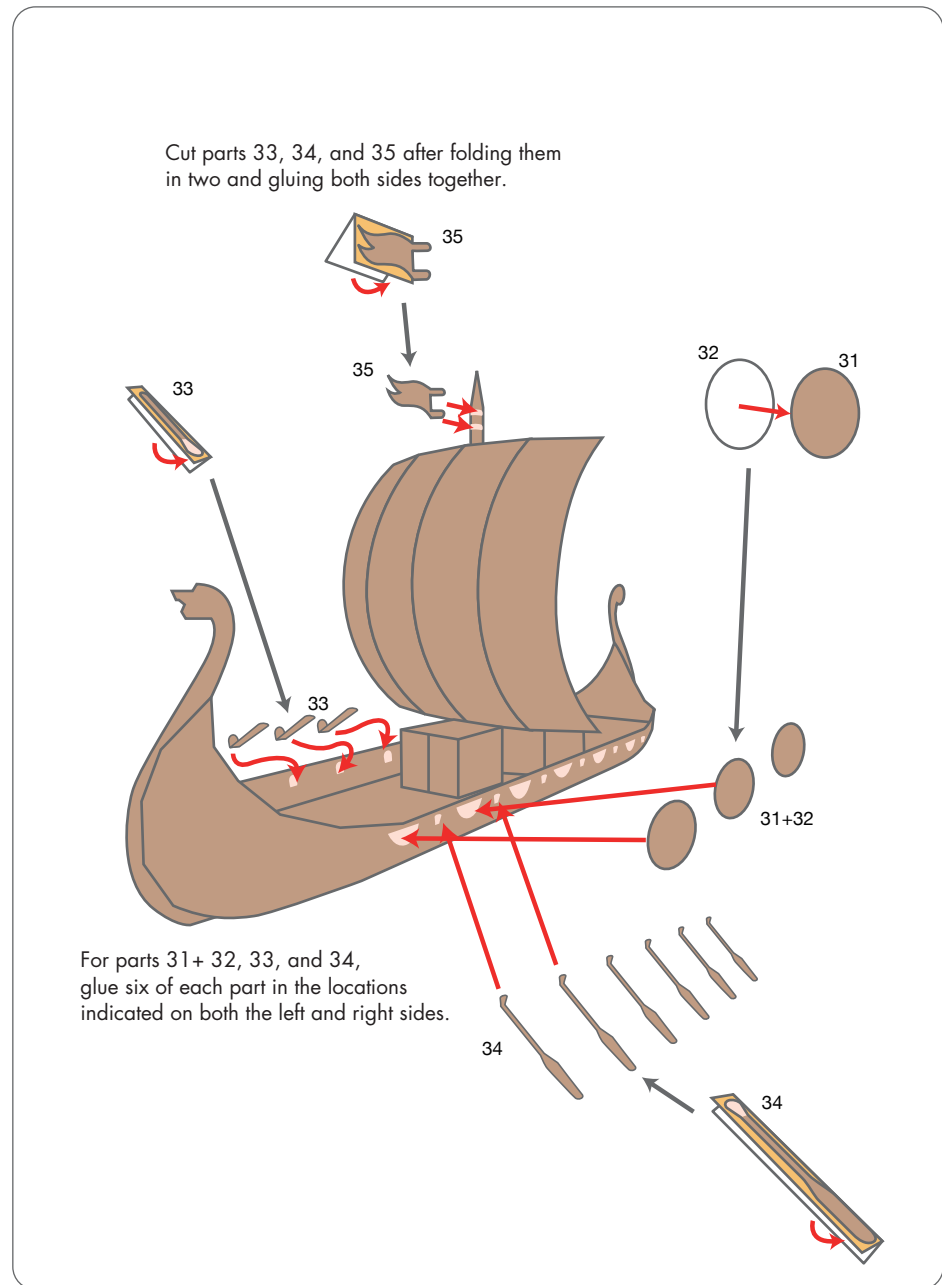
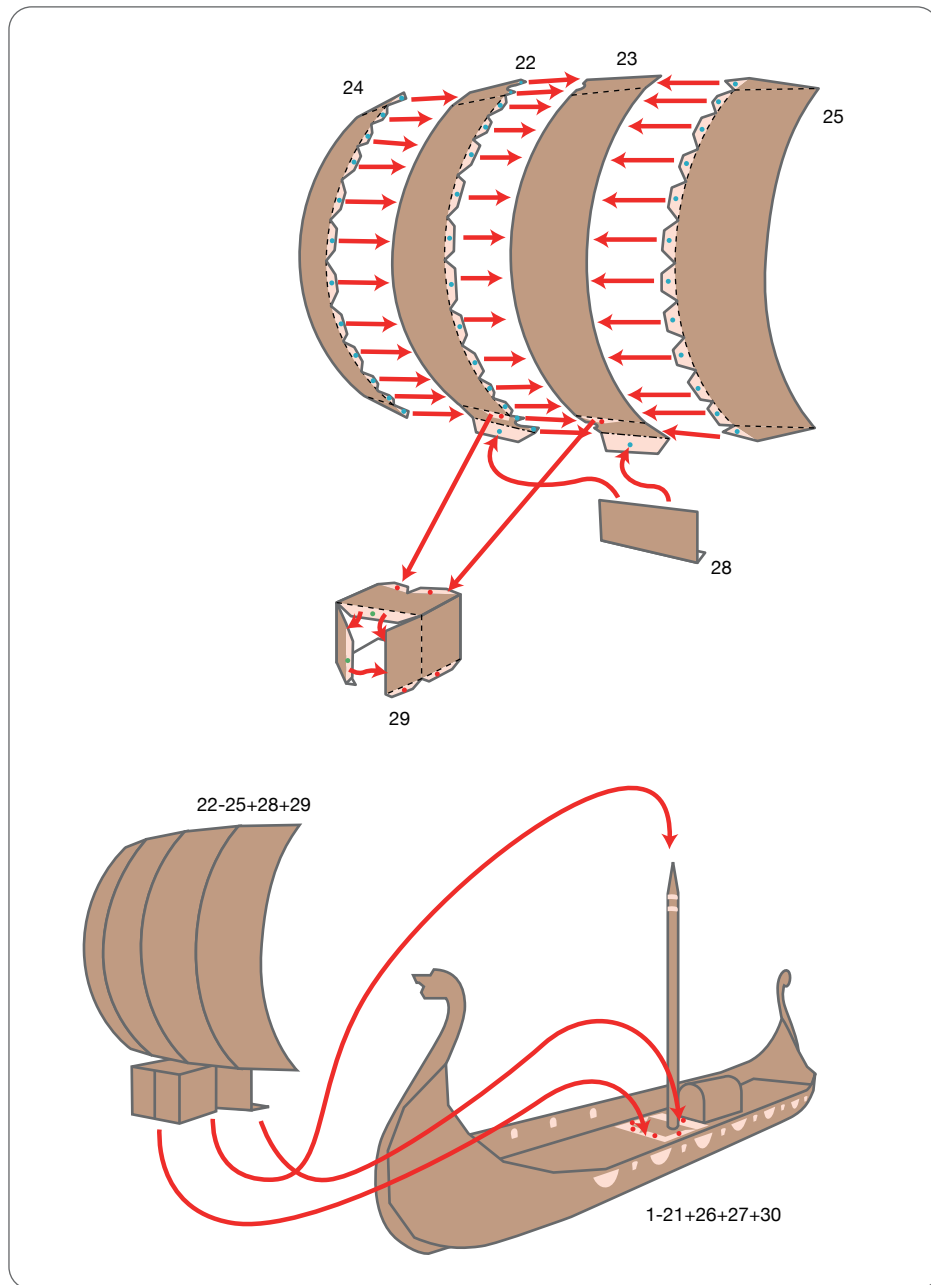

Viking craft, Norway: Assembly Instructions

Canon ® is a registered trademark of Canon Inc. © Canon Inc. © Y.Watanabe

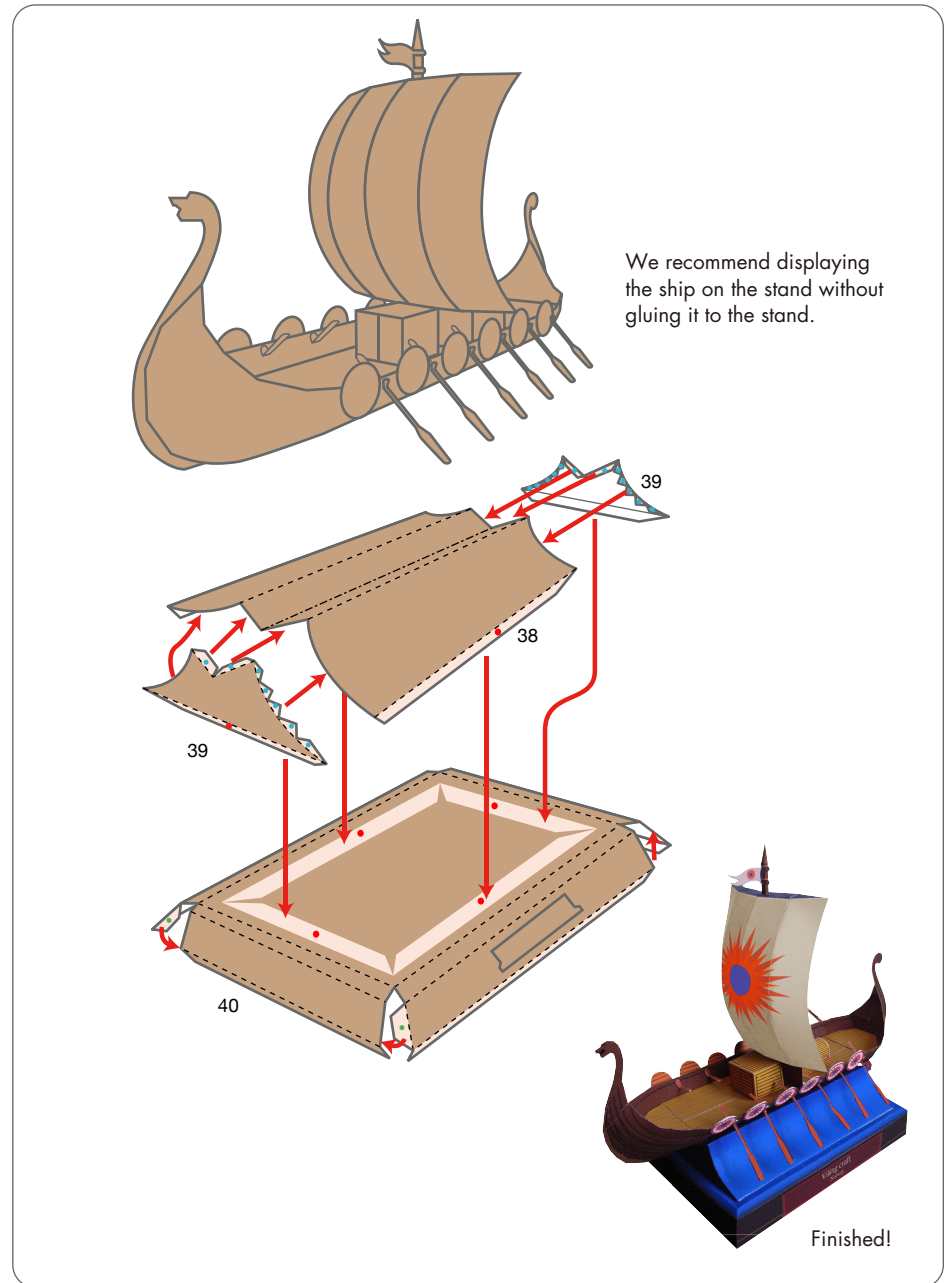
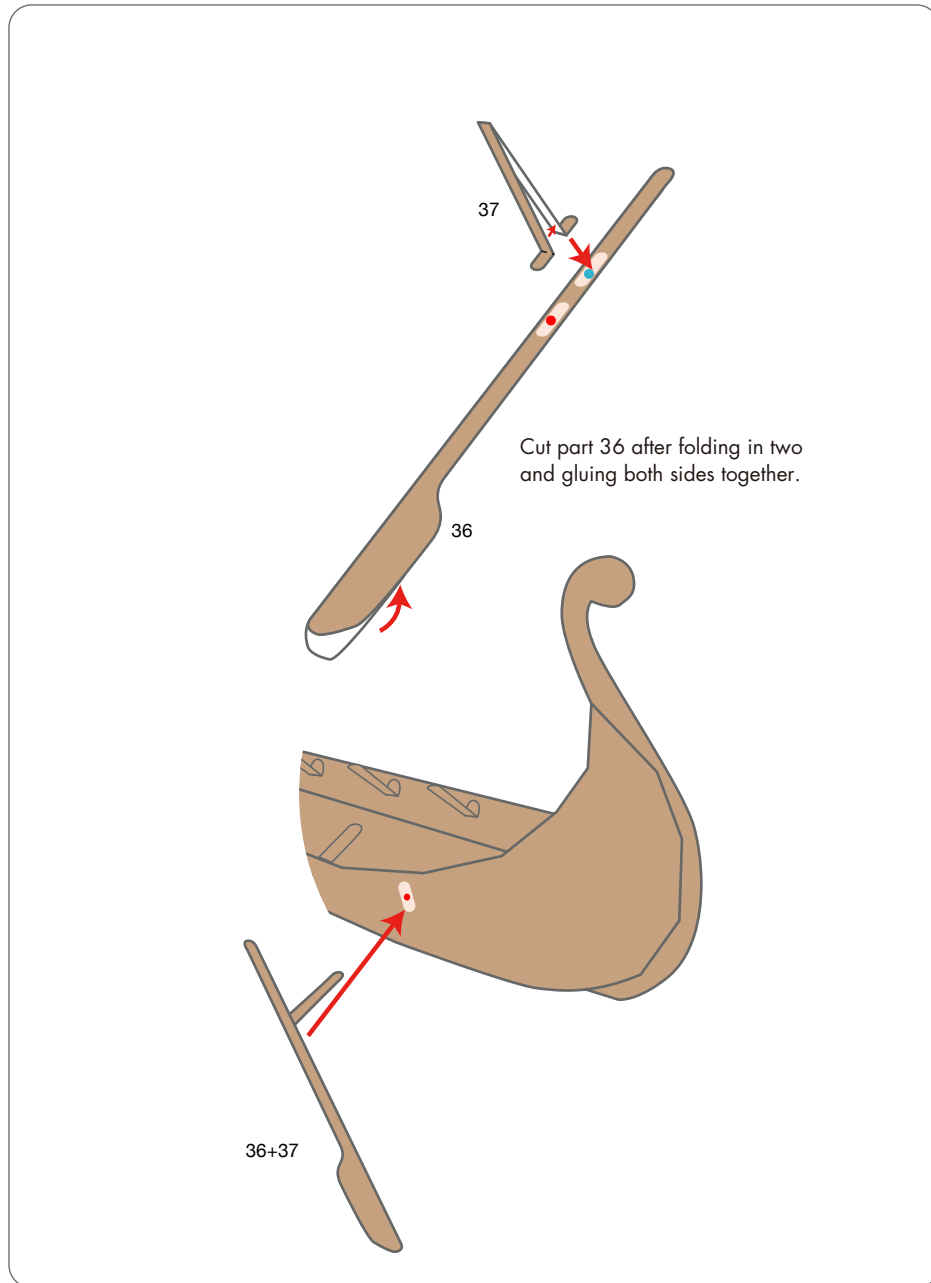

Viking craft, Norway: Pattern

Canon ® is a registered trademark of Canon Inc. © Canon Inc. © Y.Watanabe

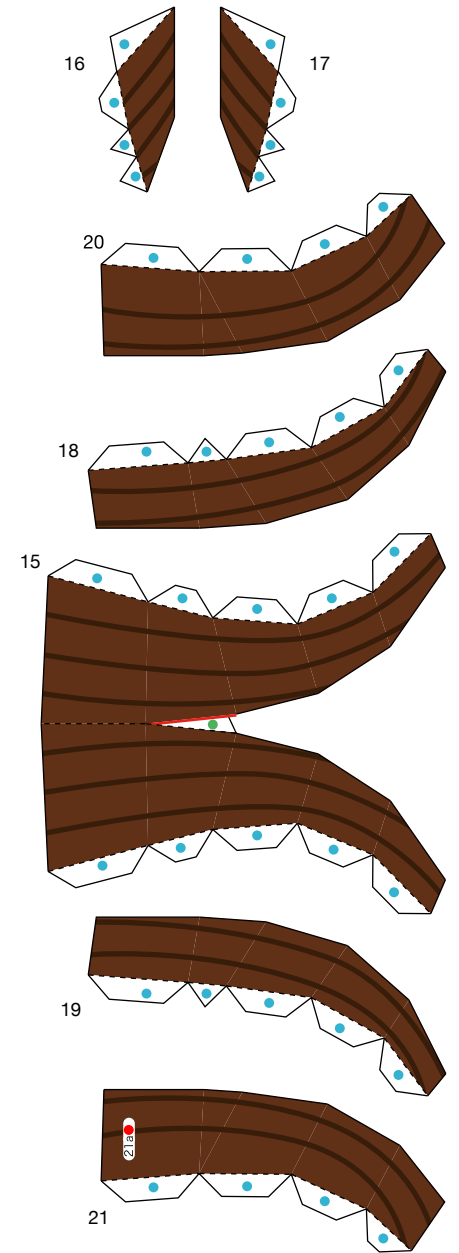
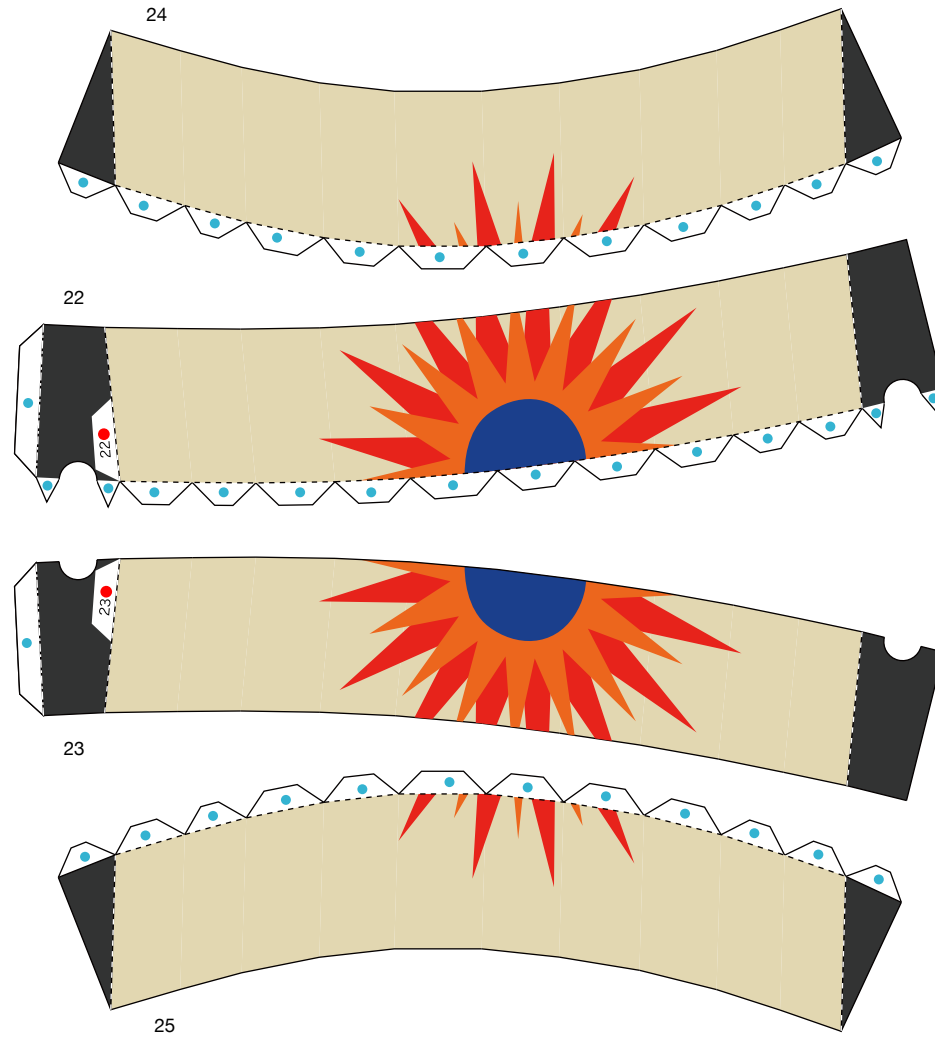
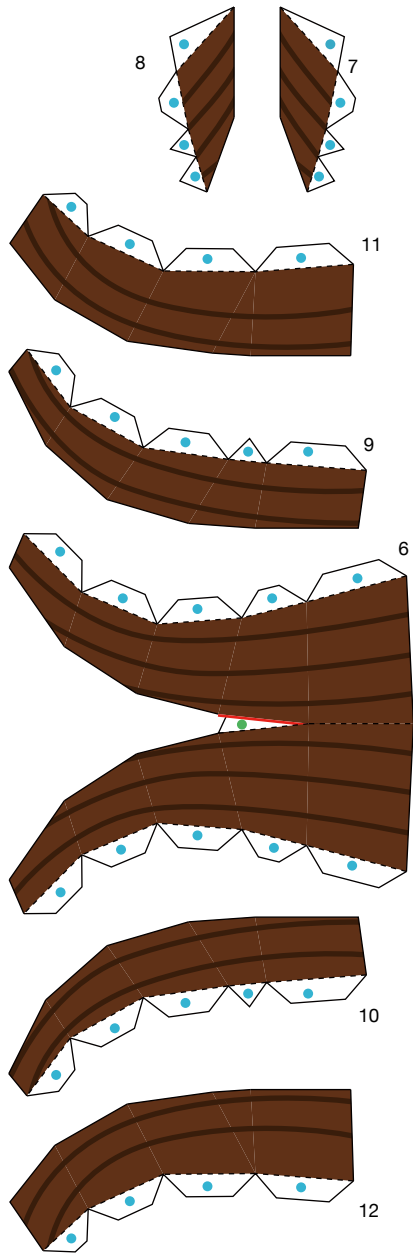

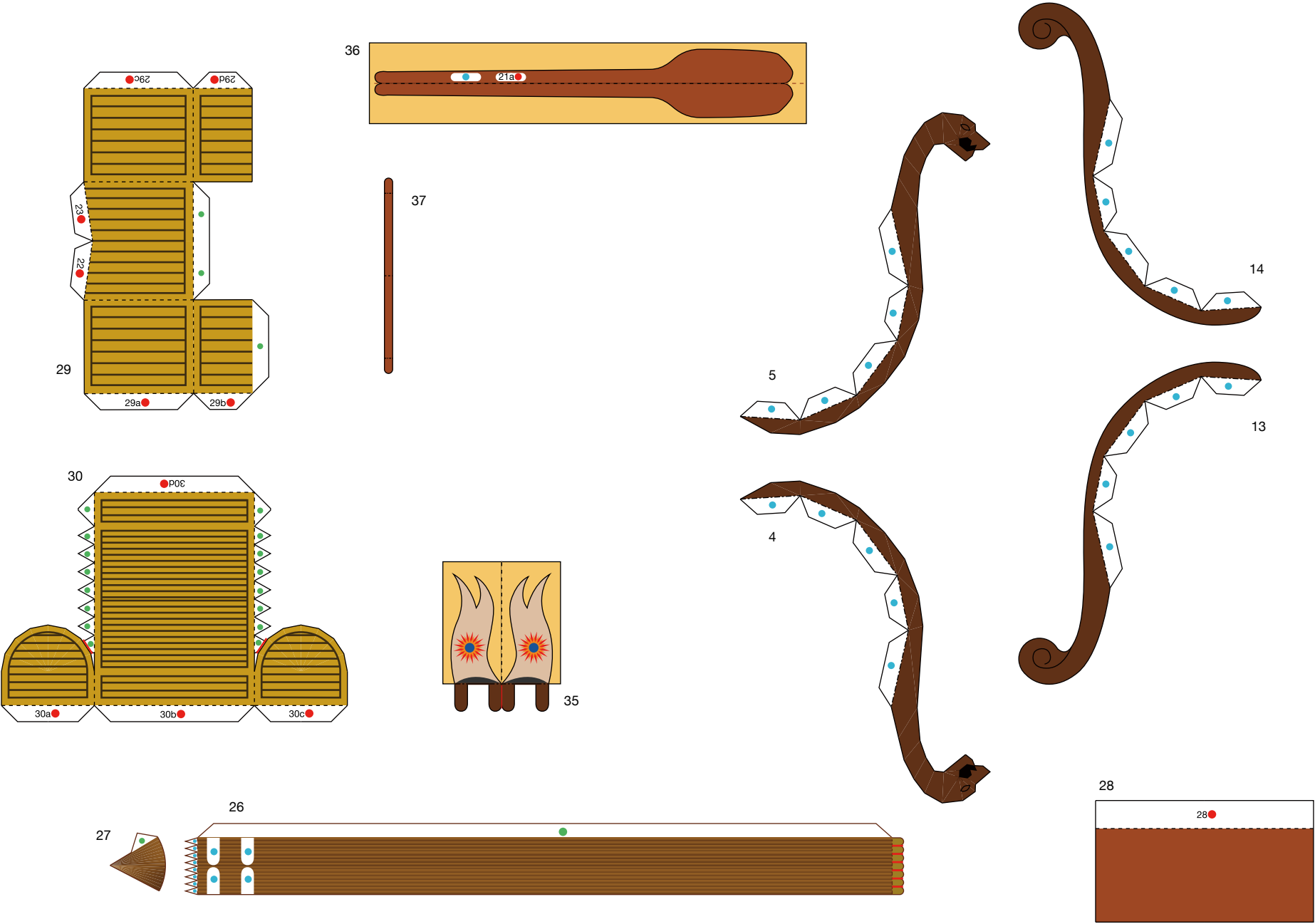

Viking craft, Norway: Pattern

Canon ® is a registered trademark of Canon Inc. © Canon Inc. © Y.Watanabe

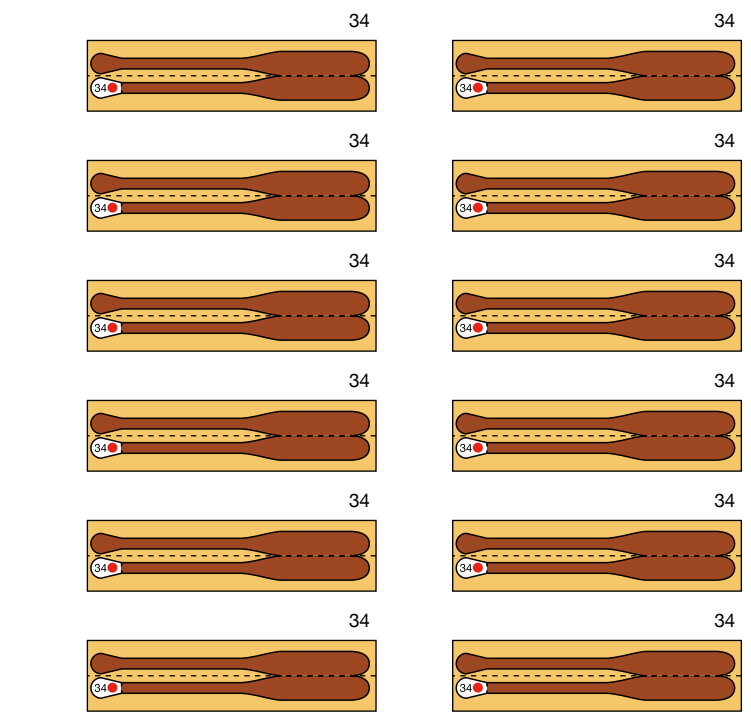
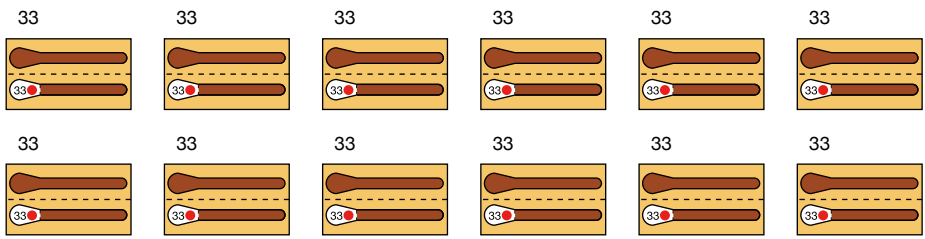
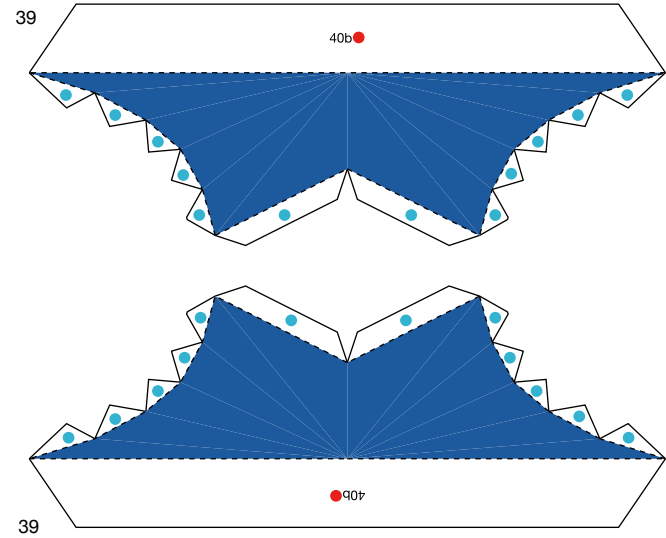
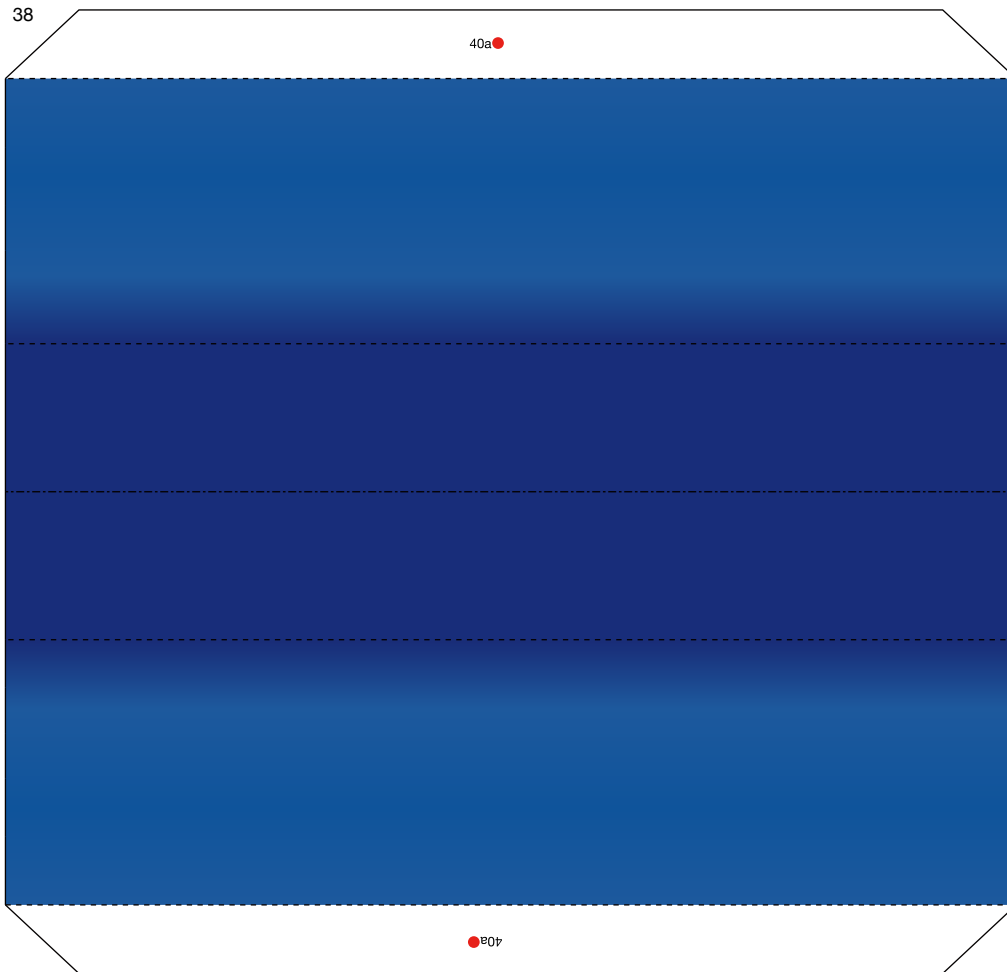

Viking craft, Norway: Pattern

Canon ® is a registered trademark of Canon Inc. © Canon Inc. © Y.Watanabe

Canon

